

New Delac

with **Wave Style** Components



- The Wave Style brings out the feeling of naturally fabric.
- Wheel type Rollers achieve super smooth operation.
- Exceptional durability satisfying the strict demands of a 10,000 open/close test.

New Delac with Wave Style Components

Wave Style Components' Unique Features



- The Wave Style creates a feeling of naturally flowing fabric.
- The curtains are draped in gentle waves about 1.5 times the width of window, resulting in a continuity of pattern and texture.
- There is a natural wave in the curtains at intervals of 80 mm (3.2").
- With its tape and accessories, it creates natural, elegant symmetrical waves.

*Pleating cord keeps waves evenly shaped, making the curtain rich and stylish.

Wave Style Structure

- Even number of hooks used in all cases.
- Rollers spaced at 80 mm (3.2") intervals to produce waves.
- Both left and right sides of curtains always end in troughs.

*To make appealing wave style curtains, use Flat Tape and Pleating Cord.

*Fabrics with soft weft threads and stiff warp threads such as plain weaves are advisable (Blackout fabrics are not recommended).

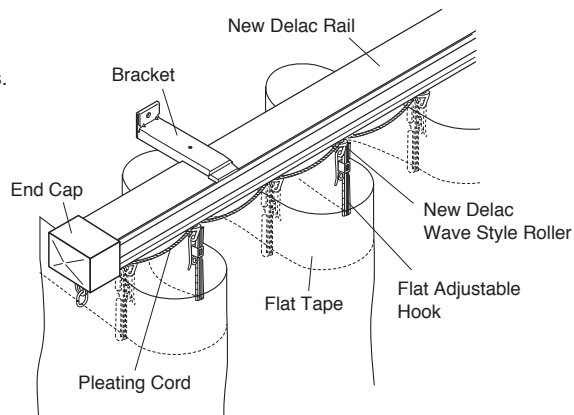

Materials and Finishes

Rail Section

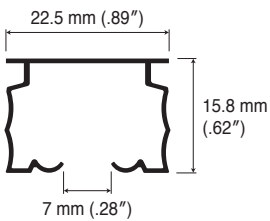

Parts	Material	Finish	
Rail	Aluminum alloy extrusion material	Silver	Alumite
		Umber	Alumite umber
		Black	Alumite black
		White	Alumite white
		Warm white	Alumite warm white

Parts	Material	Finish
Roller	Natural	High density polyethylene
Pleating Cord	White	Cord: Chemical fiber Bush: Polyacetal

Wave Style Components

Pleating Cord

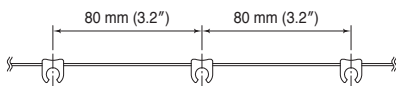

Flat Tape 75 mm

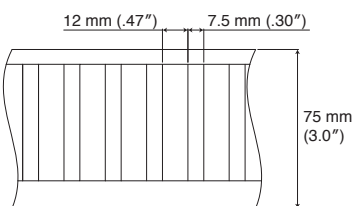

Flat Adjustable Hook 75 mm

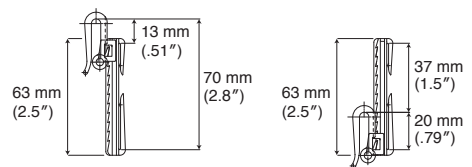

11 steps adjustable with 5 mm pitch

New Delac Wave Style Roller

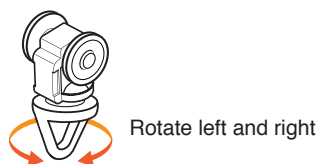
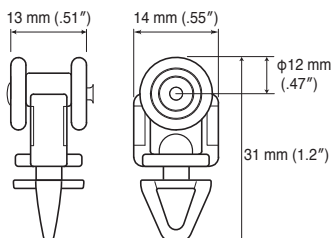

Bracket Installation Interval and Allowable Curtain Load

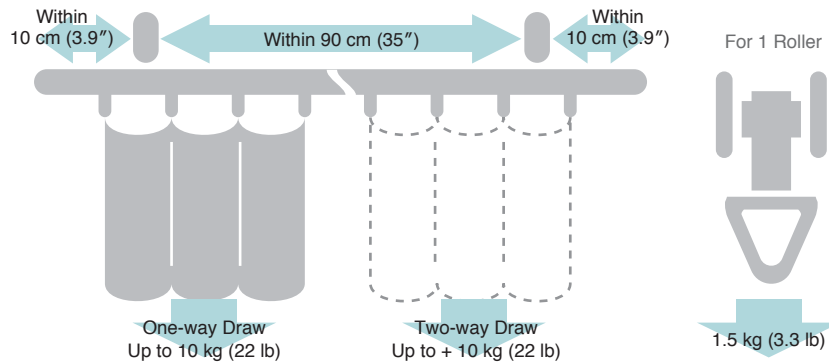

Wave Style Roller and Pleating Cord Installation

Insert the Pleating Cord into the New Delac Wave Style Roller.

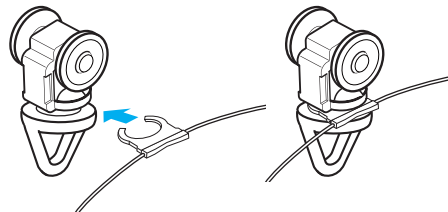

Wave Style Curtain

How to Sew Curtain with Flat Tape

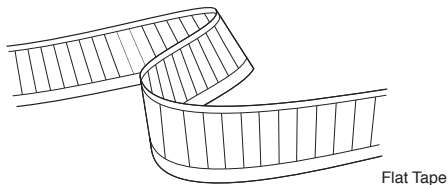

The Flat Tape for finishing the curtain wave appropriately.

Sewing Tips

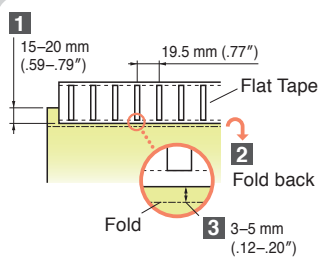

- 1 Put Flat Tape upside down so as to overlap about 15–20 mm (.59–.79") from the top edge of the curtain front side and sew it.
- 2 Fold the curtain fabric once on the back side and sew it.
- 3 Fold the curtain fabric 3–5 mm (.12–.20") away from Flat Tape.

How to Sew Curtain with Weight Tape

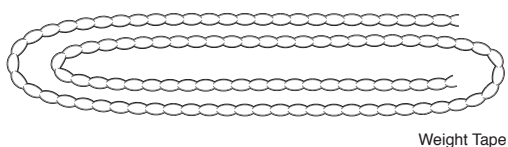

Put the Weight Tape in the curtain hem makes a appropriate curtain wave.
The Weight Tape is flexible, so it will be finished in a natural wave.

Sewing Tips

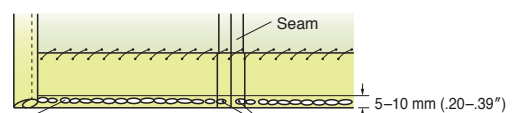

- 1 Weight Tape (Stuff to full width of the curtain)
 - 2 Close by hand sewing
- 1 Prepare the weight tape more than the width. Put the full width in the folded part of the hem.
 - 2 Close hand-sewn from the back side for each seam so that the Weight Tape becomes average.

New Delac with Wave Style Components

Curtain Baton (Option)

Using the Curtain Baton, the curtain opens /closes smoothly.
The Curtain Baton has the following effects, keep the shape of the curtain and prevent dirt.

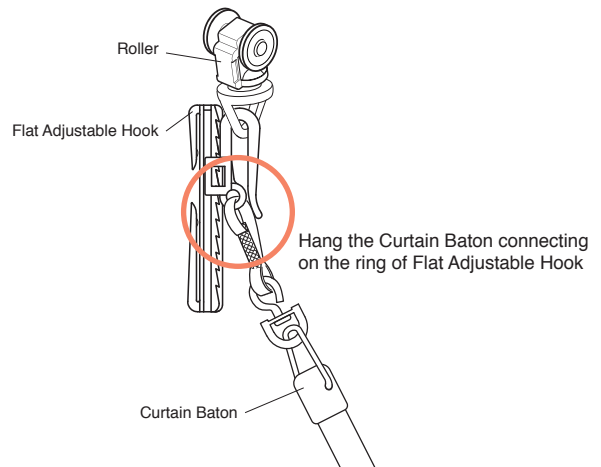
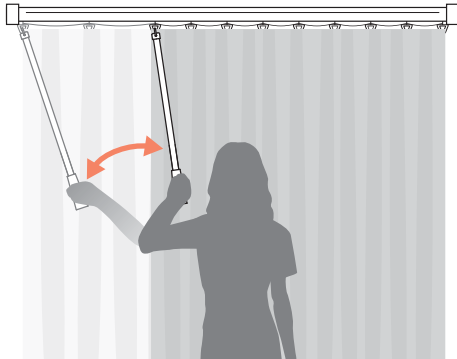

Installation Dimensions

Ceiling Attachment

Direct attachment

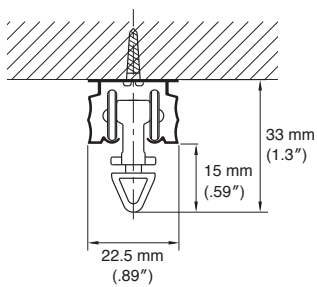

Ceiling Single Bracket
Bracket width = 18 mm (.71")

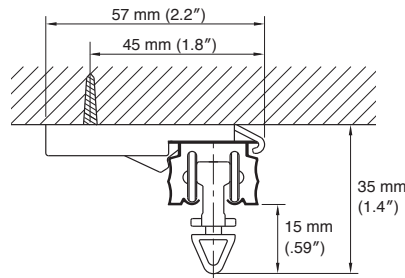

Wall Attachment

Single Bracket

Bracket width = 19 mm (.75")

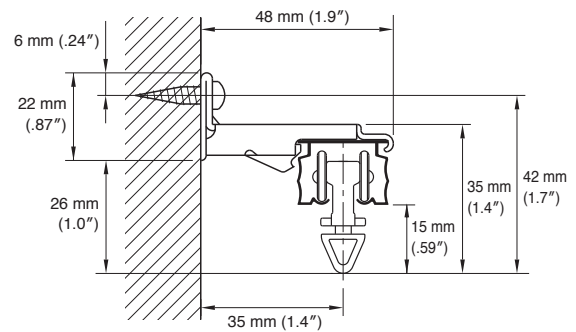

New Delac with Wave Style Components—Parts

Product Name	Product Code
New Delac Wave Style Roller Set (100 m) Roller (1,250 pcs) 80 mm (3.2") Pleating Cord (100 m)	00210355
Flat Tape 75 mm (50 m) 	00400115
Flat Adjustable Hook 75 mm (300 pcs) 	00340246

Product Name	Product Code
Weight Tape Stainless 14 (100 m) 	30004957
Curtain Baton A White 61 mm (2.4") Length φ8 mm (.32") 80 mm (3.2") φ17 mm (.67")	450 mm (18") 30010767 700 mm (28") 30010768 900 mm (35") 30010769 1,200 mm (47") 30010770 1,500 mm (59") 30010771